



### Features

- Available for 1, 2, 3, 4 & 6 operators.
- Base mounted contacts allow for easy removal of operator cover. Wiring remains with base.
- Up to 5 contact blocks can be used per operator for some combinations.
- Environmental ratings: UL/CSA Type 1, 3R, 4, 4X, 12 & 13, IP66
- Available in high impact strength polycarbonate (plastic) material.
- Rated for outdoor use.
- Enclosures can withstand light acid solutions and other chemicals.
- Metallic enclosures available.

## Plastic enclosures Modular range 1, 2 & 3 seat



1 Position

### 1-seat Plastic enclosures. Yellow top/light grey bottom

Description					Catalog No.	List Price
	Pos - 1	Pos - 2	Pos - 3	Pos - 4		
Type	Twist Release 40mm E	—	—	—	P1-ES	\$ 84.00
Color	Stop	—	—	—		
Contacts	Red	—	—	—		
Name plate	2 NC	—	—	—		
	EMERGENCY STOP	—	—	—		
Type	III. Twist Release 40mm E	—	—	—	P1-1ES	107.50
Color	40mm E-Stop	—	—	—		
Contacts	Red, 120V	—	—	—		
Name plate	2 NC, 1 LB	—	—	—		
	EMERGENCY STOP	—	—	—		

### 1-seat Plastic enclosure, dark grey top/light grey bottom

Description					Catalog No.	List Price
	Pos - 1	Pos - 2	Pos - 3	Pos - 4		
Type	3-pos sel. Main	—	—	—	P1-HOA	\$ 55.00
Color	Black	—	—	—		
Contacts	2 NO	—	—	—		
Name plate	HAND/OFF/AUTO	—	—	—		
		—	—	—		

### 2-seat Plastic enclosure, dark grey top/light grey bottom

Description					Catalog No.	List Price
	Pos - 1	Pos - 2	Pos - 3	Pos - 4		
Type	Button mom, Ext.	Button mom, Flush	—	—	P2-SS	\$ 63.20
Color	Red	Green	—	—		
Contacts	1 NC	1 NO	—	—		
Name plate	STOP	START	—	—		
			—	—		
Type	3-pos sel. Main	Pilot Light	—	—	P2-1HOARL	90.00
Color	Black	Red	—	—		
Contacts	2 NO	1 LB	—	—		
Name plate	HAND/OFF/AUTO	RUN	—	—		
			—	—		
Type	2-pos sel. Main	Pilot Light	—	—	P2-1OORL	82.00
Color	Black	Red	—	—		
Contacts	1 NO	1 LB	—	—		
Name plate	ON/OFF	RUN	—	—		
			—	—		

### 3-seat Plastic enclosure, dark grey top/light grey bottom

Description					Catalog No.	List Price
	Pos - 1	Pos - 2	Pos - 3	Pos - 4		
Type	Button mom, Ext.	Button mom, Flush	Pilot Light	—	P3-1SSRL	\$ 96.70
Color	Red	Green	Red	—		
Contacts	1 NC	1 NO	1 LB	—		
Name plate	STOP	START	RUN	—		
				—		
Type	3-pos sel. Main	Pilot Light	Pilot Light	—	P3-1HOARLGL	123.50
Color	Black	Red	Green	—		
Contacts	2 NO	1 LB	1 LB	—		
Name plate	HAND/OFF/AUTO	RUN	OFF	—		
				—		
Type	2-pos sel. Main	Pilot Light	Pilot Light	—	P3-1OORLGL	115.50
Color	Black	Red	Green	—		
Contacts	1 NO	1 LB	1 LB	—		
Name plate	ON/OFF	RUN	OFF	—		
				—		
Type	3-pos sel. Main	Button mom, Flush	Pilot Light	—	P3-1HOASRL	109.60
Color	Black	Green	Red	—		
Contacts	2 NO	1 NO	1 LB	—		
Name plate	HAND/OFF/AUTO	START	RUN	—		
				—		
Type	Twist Release 40mm E Stop	3-pos sel. Main	Pilot Light	—	P3-1ESHOARL	145.50
Color	Red	Black	Red	—		
Contacts	2 NC	2 NO	1 LB	—		
Name plate	EMERGENCY STOP	HAND/OFF/AUTO	RUN	—		
				—		

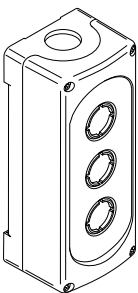

3 Position

2 Position

1 Position

# Plastic enclosures

## Modular range

### 4 seat

Pilot Devices  
Enclosed

#### 4-seat Plastic enclosure, dark grey top/light grey bottom

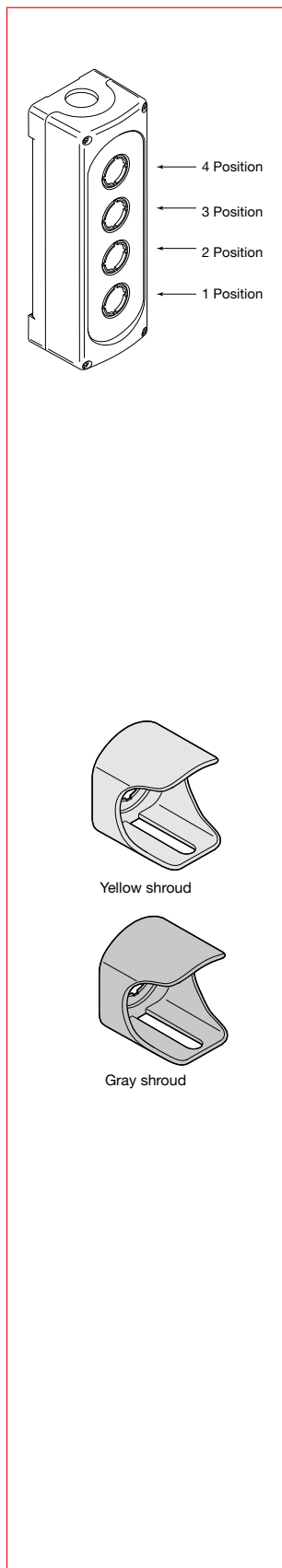

Description					Catalog No.	List Price
	Pos - 1	Pos - 2	Pos - 3	Pos - 4		
Type	Button mom., Ext.	Button mom., Flush	Pilot Light	Pilot Light	<b>P4-1SSRLGL</b>	<b>\$ 134.20</b>
Color	Red	Green	Green	Red		
Contacts	1 NC	1 NO	1 LB	1 LB		
Name plate	STOP	START	OFF	RUN		
Type	3-pos sel. Main	Button mom., Flush	Pilot Light	Pilot Light	<b>P4-1HOASRLGL</b>	<b>147.10</b>
Color	Black	Green	Green	RED		
Contacts	2 NO	1 NO	1 LB	1 LB		
Name plate	HAND/OFF/AUTO	START	OFF	RUN		
Type	3-pos sel. Main	Pilot Light	Pilot Light	Pilot Light	<b>P4-1HOARLYLGL</b>	<b>161.00</b>
Color	Black	Green	Yellow	Red		
Contacts	2 NO	1 LB	1 LB	1 LB		
Name plate	HAND/OFF/AUTO	OFF	FAULT	RUN		
Type	2-pos. sel. Main	Pilot Light	Pilot Light	Pilot Light	<b>P4-1OORLYLGL</b>	<b>153.00</b>
Color	Black	Green	Yellow	Red		
Contacts	1 NO	1 LB	1 LB	1 LB		
Name plate	ON/OFF	OFF	FAULT	RUN		
Type	Twist Release 40mm E Stop	Button mom., Ext.	Button mom., Flush	Pilot Light	<b>P4-1ESSRL</b>	<b>156.20</b>
Color	Red	Red	Green	Red		
Contacts	2 NC	1 NC	1 NO	1 LB		
Name plate	EMERGENCY STOP	STOP	START	RUN		
Type	Twist Release 40mm E Stop	3-pos. sel. Main	Pilot Light	Pilot Light	<b>P4-1ESHOARLGL</b>	<b>183.00</b>
Color	Red	Black	Green	Red		
Contacts	2 NC	2 NO	1 LB	1 LB		
Name plate	EMERGENCY STOP	HAND/OFF/AUTO	OFF	RUN		
Type	Twist Release 40mm E Stop	2-pos sel. Main	Pilot Light	Pilot Light	<b>P4-1ESOORLGL</b>	<b>175.00</b>
Color	Red	Black	Green	Red		
Contacts	2 NC	1 NO	1 LB	1 LB		
Name plate	EMERGENCY STOP	ON/OFF	OFF	RUN		

8

#### Shrouds

Color	Catalog No.	Reference Code	List Price
Yellow	MA1-8053	1SFA611920R8053	<b>\$ 12</b>
Gray	MA1-8128	1SFA611920R8128	

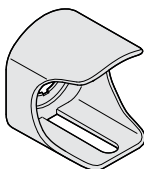

Yellow shroud

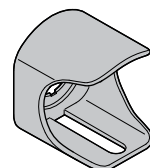

Gray shroud

## Degree of protection IP 66 Modular range

Empty plastic enclosures Now with stainless steel screws

Size	Color top/bottom	Catalog No.	Ref. Code	List Price
1-seat	Dark grey/Light grey	<b>MEP1-0</b>	1SFA 611 811 R1000	<b>\$ 28.00</b>
1-seat	Yellow/Light grey	<b>MEPY-0</b>	1SFA 611 821 R1000	<b>28.00</b>
2-seat	Dark grey/Light grey	<b>MEP2-0</b>	1SFA 611 812 R1000	<b>32.00</b>
3-seat	Dark grey/Light grey	<b>MEP3-0</b>	1SFA 611 813 R1000	<b>36.00</b>
4-seat	Dark grey/Light grey	<b>MEP4-0</b>	1SFA 611 814 R1000	<b>44.00</b>
6-seat	Dark grey/Light grey	<b>MEP6-0</b>	1SFA 611 816 R1000	<b>52.00</b>

### When Ordering

- Select operators from page 8.4 and 8.38.  
N.B. Selector switches with short handle for vertically mounted selector switches must be Ref.ed from page 8.45 - 8.46
- Select contact blocks and lamp blocks for **rear** mounting, see page 8.44.
- Accessories, see page 8.43  
N.B. **One spacer per operator** has to be Ref.ed if legend plate is not used.  
(for rear mounted pilot devices)

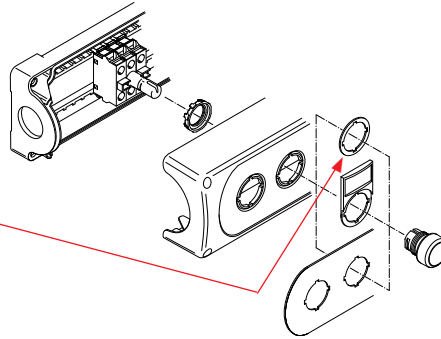

# Accessories

## Modular range

Pilot Devices  
Enclosed

8

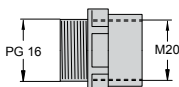
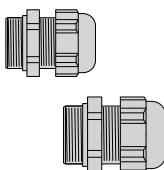
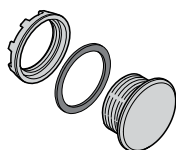
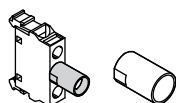
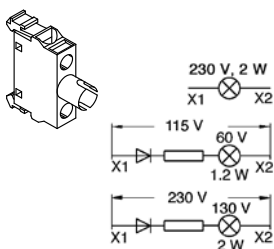
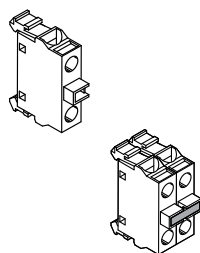

### Contact blocks for rear mounting

Description	Catalog No.	Ref. Code	List Price
<b>Contact block</b>			
1NO	<b>MCB-10B</b>	1SFA 611 610 R2001	\$ 8.00
1NC	<b>MCB-01B</b>	1SFA 611 610 R2010	

<b>Double contact block</b>			
2NO	<b>MCB-20B</b>	1SFA 611 610 R2002	16.00
2NC	<b>MCB-02B</b>	1SFA 611 610 R2020	
1NO+1NC	<b>MCB-11B</b>	1SFA 611 610 R2011	

<b>Contact block with gold plated contacts</b>			
1NO	<b>MCB-10BG</b>	1SFA 611 610 R2101	16.00
1NC	<b>MCB-01BG</b>	1SFA 611 610 R2110	

Description	Catalog No.	Ref. Code	List Price
<b>Lamp blocks</b>			
<b>For max. 2 W, 230 V AC and DC filament bulb or LED</b>			
115 V AC supply voltage. <b>For 60 V filament bulb max. 1.2 W</b>	<b>MLB-1B</b>	1SFA 611 620 R2001	17.50
230 V AC supply voltage. <b>For 130 V filament bulb max. 2 W</b>	<b>MLB-2B</b>	1SFA 611 620 R2002	21.50
	<b>MLB-3B</b>	1SFA 611 620 R2003	21.50

Description	Catalog No.	Ref. Code	List Price
<b>Protective sleeve</b>			
To make a rear mounted lamp block screen protected. IP20	<b>5396 0543-1</b>	5396 0543-1	\$ 2.00

Description	Catalog No.	Ref. Code	List Price
<b>Earthing terminal</b>			
For plastic enclosure.	<b>MA5-2005</b>	1SFA 611 925 R3005	\$ 2.00

Description	Catalog No.	Ref. Code	List Price
<b>Spacer</b>			
1 mm thick. Needed when legend plates are not used in plastic enclosures.			
Spacer (Packing unit 10 pieces)	<b>SK 615 516-1</b>	SK 615 516-1	\$ 1.00
Spacer for Modular emergency stop pushbutton (Packing unit 10 pieces)	<b>KA1-8045</b>	1SFA 616 920 R 8045	1.00

Description	Catalog No.	Ref. Code	List Price
<b>Blanking plug (22mm)</b>			
Grey plastic	<b>MA1-8129</b>	1SFA 611 920 R 8129	\$ 5.80
Black plastic	<b>MA1-8130</b>	1SFA 611 920 R8130	5.80

Description	Catalog No.	Ref. Code	List Price
<b>Cable gland</b>			
PG 13.5	<b>MA5-3006</b>	1SFA 611 925 R3006	\$ 8.40
PG 16	<b>MA5-3007</b>	1SFA 611 925 R3007	9.40

Description	Catalog No.	Ref. Code	List Price
<b>Nut</b>			
PG 13.5	<b>MA5-3008</b>	1SFA 611 925 R3007	\$ 2.60
PG 16	<b>MA5-3009</b>	1SFA 611 925 R3009	2.60

Description	Catalog No.	Ref. Code	List Price
<b>Adaptor</b>			
PG 16/M20	<b>MA5-3010</b>	1SFA 611 925 R3010	\$ 16.20

## Two position selector switches for mounting in vertically mounted enclosures Modular range

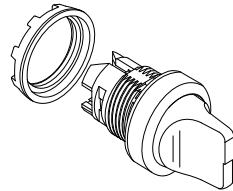
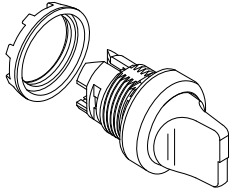

Bezel in black plastic as standard

Bezel in metal:

Replace '1' in the:

Catalog No. M2SSX-1 0X

Ref. Code 1SFA611XXX R 1XXX

3 for metal bezel

4 for grey plastic bezel

### Contact functions

Block positions as seen from operator front.

Handle position	Left block	Right block
A (B)	O	O
O	x	x

O = not actuated (normal state)

x = actuated (state changed)

### Non-illuminated operator ... ①

Symbol	Handle color	Catalog No.	Ref. Code	List Price
<b>with short handle</b>				
<b>Maintained</b>				
	Red	<b>M2SSV1-10R</b>	1SFA 611 220 R1001	\$ 11.00
	Black	<b>M2SSV1-10B</b>	1SFA 611 220 R1006	
<b>Maintained</b>				
	Red	<b>M2SSV2-10R</b>	1SFA 611 221 R1001	11.00
	Black	<b>M2SSV2-10B</b>	1SFA 611 221 R1006	
<b>Momentary, spring return from C to B</b>				
	Red	<b>M2SSV3-10R</b>	1SFA 611 222 R1001	14.00
	Black	<b>M2SSV3-10B</b>	1SFA 611 222 R1006	

### Illuminated operator ... ① ②

Symbol	Handle color	Catalog No.	Ref. Code	List Price
<b>with short handle</b>				
<b>Maintained</b>				
	Red	<b>M2SSV1-11R</b>	1SFA 611 220 R1101	\$ 17.00
	Green	<b>M2SSV1-11G</b>	1SFA 611 220 R1102	
	Yellow	<b>M2SSV1-11Y</b>	1SFA 611 220 R1103	
<b>Maintained</b>				
	Red	<b>M2SSV2-11R</b>	1SFA 611 221 R1101	17.00
	Green	<b>M2SSV2-11G</b>	1SFA 611 221 R1102	
	Yellow	<b>M2SSV2-11Y</b>	1SFA 611 221 R1103	
<b>Momentary, spring return from C to B</b>				
	Red	<b>M2SSV3-11R</b>	1SFA 611 222 R1101	26.00
	Green	<b>M2SSV3-11G</b>	1SFA 611 222 R1102	
	Yellow	<b>M2SSV3-11Y</b>	1SFA 611 222 R1103	

① No contact in center position

② Lamp block for max 230 V AC/DC. Bulb not included. Other lamp block see Accessories

## Three position selector switches for mounting in vertically mounted enclosures Modular range

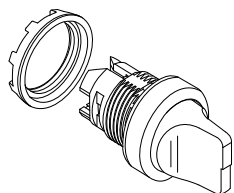
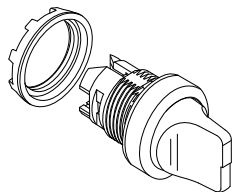

**Bezel in black plastic as standard**  
**Bezel in metal:**  
Replace '1' in the:  
Catalog No. M3SSX-1 0X  
Ref. Code 1SFA611XXX R 1XXX  
**3** for metal bezel  
**4** for grey plastic bezel

### Contact functions

Block positions as seen from operator front.

Handle position	Left block	Right block
A	x	○
B	○	○
C	○	x

### Non-illuminated operator ... ①

Symbol	Handle color	Catalog No.	Ref. Code	List Price
<b>with short handle</b>				
<b>Maintained</b>				
	Red	<b>M3SSV1-10R</b>	1SFA 611 230 R1001	\$ 11.00
	Black	<b>M3SSV1-10B</b>	1SFA 611 230 R1006	
<b>Momentary, spring return from A to B and from C to B</b>				
	Red	<b>M3SSV2-10R</b>	1SFA 611 231 R1001	14.00
	Black	<b>M3SSV2-10B</b>	1SFA 611 231 R1006	
<b>Momentary, spring return from C to B</b>				
	Red	<b>M3SSV3-10R</b>	1SFA 611 232 R1001	14.00
	Black	<b>M3SSV3-10B</b>	1SFA 611 232 R1006	

### Illuminated operator ... ① ②

Symbol	Handle color	Catalog No.	Ref. Code	List Price
<b>with short handle</b>				
<b>Maintained</b>				
	Red	<b>M3SSV1-11R</b>	1SFA 611 230 R1101	\$ 17.00
	Green	<b>M3SSV1-11G</b>	1SFA 611 230 R1102	
	Yellow	<b>M3SSV1-11Y</b>	1SFA 611 230 R1103	
<b>Momentary, spring return from A to B and from C to B</b>				
	Red	<b>M3SSV2-11R</b>	1SFA 611 231 R1101	26.00
	Green	<b>M3SSV2-11G</b>	1SFA 611 231 R1102	
	Yellow	<b>M3SSV2-11Y</b>	1SFA 611 231 R1103	
<b>Momentary, spring return from C to B</b>				
	Red	<b>M3SSV3-11R</b>	1SFA 611 232 R1001	26.00
	Green	<b>M3SSV3-11G</b>	1SFA 611 232 R1002	
	Yellow	<b>M3SSV3-11Y</b>	1SFA 611 232 R1003	

**Contact blocks, lamp block and holder** See Page 8.45

① No contact in center position

② Lamp block for max 230 V AC/DC. Bulb not included. Other lamp block see Accessories

## Compact E-Stop Component parts

### 1-seat emergency-stop enclosures

	Description	Catalog Number	Order Code	List Price
	Enclosure 1-Seat Dark grey/light grey 50D <sub>mm</sub> x 65W <sub>mm</sub> 65H <sub>mm</sub>	<b>CEP1-0</b>	1SFA 619 811 R1000	<b>\$ 22</b>
	Enclosure 1-Seat Yellow/light grey 50D <sub>mm</sub> x 65W <sub>mm</sub> 65H <sub>mm</sub>	<b>CEPY1-0</b>	1SFA 619 821 R1000	<b>22</b>
	Shroud For emergency stops; yellow 30D <sub>mm</sub> x 45W <sub>mm</sub> 60H <sub>mm</sub>	<b>CA1-8053</b>	1SFA 619 920 R8053	<b>10</b>
	Shroud For machine stops; dark grey 30D <sub>mm</sub> x 45W <sub>mm</sub> 60H <sub>mm</sub>	<b>CA1-8054</b>	1SFA 619 920 R8054	<b>10</b>
	Legend plate, yellow aluminum 60mm	<b>CA6-1026</b>	1SFA619930R1026	<b>6</b>



## Compact E-Stop Assembled stations

### Assembled 1-seat emergency stop enclosures

	Description	Catalog Number	Order Code	List Price
	Emergency Stop Enclosure Twist release; red button 2NC	<b>CEPY1-1001</b>	1SFA 619 821 R1001	<b>\$ 73</b>
	Emergency Stop Enclosure Pull release; red button 2NC	<b>CEPY1-1002</b>	1SFA 619 821 R1002	<b>73</b>
	Emergency Stop Enclosure with Shroud Twist release; red button 2NC	<b>CEPY1-2001</b>	1SFA 619 821 R2001	<b>84</b>
	Emergency Stop Enclosure with Shroud Pull release; red button 2NC	<b>CEPY1-2002</b>	1SFA 619 821 R2002	<b>84</b>
	Machine Stop Enclosure Twist release; black button 1NO + 1NC	<b>CEP1-1001</b>	1SFA 619 81 R1002	<b>73</b>
	Machine Stop Enclosure Pull release; black button 1NO + 1NC	<b>CEP1-1002</b>	1SFA 619 811 R1002	<b>73</b>
	Machine Stop Enclosure with Shroud Twist release; black button 1NO + 1NC	<b>CEP1-2001</b>	1SFA 619 811 R2001	<b>84</b>
	Machine Stop Enclosure with Shroud Pull release; black button 1NO + 1NC	<b>CEP1-2002</b>	1SFA 619 811 R2002	<b>84</b>



## Notes

---